



Technical data

UCP217

Bearing units

Grey cast housing, radial insert ball bearing with socket set screws, seal with slinger

KIT CONTENT

UC217G2, P217

VISUAL (S)

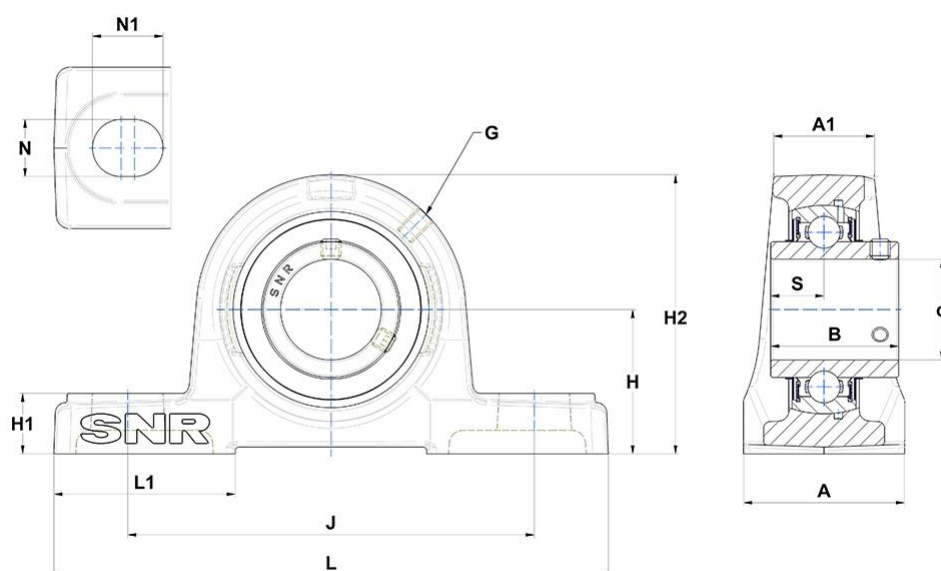

PRODUCT DIMENSIONS

Brand	SNR
Housing width (A)	83 mm
A1	53 mm
Width of IR (B)	85,7 mm
Shaft dia (d)	85 mm
Grease fitting (G)	M10x1
H	95,2 mm
H1	32 mm

PRODUCT DIMENSIONS

H2	187 mm
Mounting hole distance (J)	247 mm
Housing length (L)	310 mm
L1	96 mm
Mounting hole dimension (N)	25 mm
N1	31 mm
Dist. cent. of raceway to face IR on side opp. lock. device	34,1 mm

OTHER FEATURES

Mass	10,88 kg
Recommended tightening torque for set screw [Nm]	33.0 N-m

PRODUCT PERFORMANCE

Dynamic load rating (C)	83,2 kN
Static load rating (C0)	63,8 kN
Operating temperature min.	-20 °C
Operating temperature max.	100 °C