



Technical data

UCP212 Bearing units

Grey cast housing, radial insert ball bearing with socket set screws, seal with slinger

KIT CONTENT

UC212G2, P212

VISUAL (S)

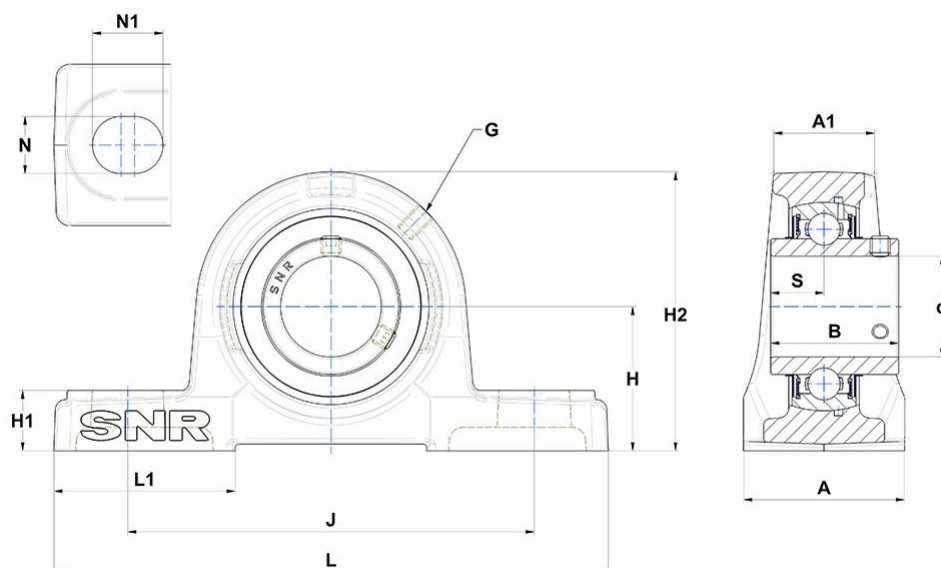

PRODUCT DIMENSIONS

Brand	SNR
Housing width (A)	70 mm
A1	44 mm
Width of IR (B)	65,1 mm
Shaft dia (d)	60 mm
Grease fitting (G)	M6x1
H	69,8 mm
H1	25 mm

PRODUCT DIMENSIONS

H2	138 mm
Mounting hole distance (J)	184 mm
Housing length (L)	241 mm
L1	70 mm
Mounting hole dimension (N)	20 mm
N1	25 mm
Dist. cent. of raceway to face IR on side opp. lock. device	25,4 mm

OTHER FEATURES

Mass	5,03 kg
Recommended tightening torque for set screw [Nm]	22.0 N-m

PRODUCT PERFORMANCE

Dynamic load rating (C)	52,5 kN
Static load rating (C0)	32,8 kN
Operating temperature min.	-20 °C
Operating temperature max.	100 °C